

# DUST EXTRACTOR CV 430 WD

USER MANUAL

Translated instruction manual



SAINT-GOBAIN







# CE Declaration of Conformity

The undersigned manufacturer:

**SAINT - GOBAIN ABRASIVES S.A.  
190 KENNEDY BD. J. F.  
L-4930 BASCHARAGE**

Declares that the following new equipment:

Vacuum cleaner: <b>DUST EXTRACTOR CV 430 P 230V WD</b>	Code: <b>70184632736</b>
<b>DUST EXTRACTOR CV 430 P 110V WD</b>	Code: <b>70184632994</b>
<b>DUST EXTRACTOR CV 430 I 230V WD</b>	Code: <b>70184632741</b>
<b>DUST EXTRACTOR CV 430 I 110V WD</b>	Code: <b>70184633140</b>

complies with the provisions of the Guidelines:

- **"Machinery" 2006/42/EC**
- **"Electromagnetic compatibility" 2014/30/EU**
- **"Low Voltage" 2014/35/EU**

And to the European standard:

- **EN ISO 12100**
- **EN 60204-1**
- **EN 61000-6-3**

Valid for machines with a serial number from: 4503430198001

Where technical documents are kept:

Saint-Gobain Abrasives 190, Bd. J. F. Kennedy 4930 BASCHARAGE, LUXEMBOURG

This declaration of conformity becomes null and void if the product is processed or modified without our consent.

Bascharage, 24.08.2023.

François Chianese, authorised representative and responsible for the technical file.  
Bascharage, Luxembourg.



**CV 430 WD  
USER MANUAL  
TABLE OF CONTENTS**

<b><u>1</u></b>	<b><u>Introduction .....</u></b>	<b><u>6</u></b>
<b><u>2</u></b>	<b><u>Intended use .....</u></b>	<b><u>6</u></b>
<b><u>3</u></b>	<b><u>Safety Instructions .....</u></b>	<b><u>6</u></b>
<b><u>4</u></b>	<b><u>Machine data.....</u></b>	<b><u>8</u></b>
<b>4.1</b>	<b><i>Machine Description .....</i></b>	<b><i>8</i></b>
<b>4.2</b>	<b><i>Technical data .....</i></b>	<b><i>9</i></b>
<b>4.3</b>	<b><i>Machine insert .....</i></b>	<b><i>10</i></b>
<b><u>5</u></b>	<b><u>Performance Tolerances.....</u></b>	<b><u>10</u></b>
<b><u>6</u></b>	<b><u>Using the vacuum cleaner .....</u></b>	<b><u>11</u></b>
<b>6.1</b>	<b><i>Dust extraction / instructions for use .....</i></b>	<b><i>11</i></b>
<b>6.2</b>	<b><i>Liquid suction / instructions for use .....</i></b>	<b><i>12</i></b>
<b><u>7</u></b>	<b><u>Maintenance.....</u></b>	<b><u>13</u></b>
<b><u>8</u></b>	<b><u>End of Product Life .....</u></b>	<b><u>13</u></b>
<b><u>9</u></b>	<b><u>Breakdowns – Cause and Repair .....</u></b>	<b><u>14</u></b>
<b>9.1</b>	<b><i>Fault Tracking.....</i></b>	<b><i>14</i></b>
<b>9.2</b>	<b><i>After-sales service.....</i></b>	<b><i>14</i></b>
<b>9.3</b>	<b><i>Parts .....</i></b>	<b><i>15</i></b>

## 1 Introduction

This manual describes the functions of your vacuum cleaner.

It is the buyer's responsibility to ensure that the vacuum cleaner is used by persons who have read this manual. The purchaser is not, in any way, authorized to modify or alter the vacuum, under penalty of cancellation of the warranty and release of any liability, on the part of the manufacturing company, with respect to any property or personal damage.

If the instruction manual is lost or damaged, please contact the manufacturer.

If the vacuum cleaner is sold, please give this instruction manual to the future owner or point out the manufacturer's references.

Before delivery and in order to ensure its proper functioning, the vacuum cleaner is subjected to an electrical test, according to strict internal procedures and with the help of modern equipment specific to the electrical test, calibrated every year.

## 2 Intended use

Suitable for vacuuming dust and liquids.

Robust and powerful, easy to use, thanks to the accessories with which it is equipped, it is truly an effective instrument for deep and quick cleaning. This device is designed for commercial use; For example, in hotels, schools, hospitals, agencies, shops, offices, and rental agencies.

## 3 Safety Instructions

Read the instructions carefully before using the vacuum cleaner so that you can always operate safely.

**Caution: Before using the device, all parts of the device must be mounted correctly. Check that the planned filter elements are installed correctly and that they are efficient.**

- This appliance is not intended for use by persons (including children) with reduced physical, sensory or mental abilities or by persons lacking experience and skills.
- Children should be supervised so that they do not play with the device.
- Operators must be properly instructed in the use of this device.
- Packaging components can be potential hazards (e.g. plastic bags): keep them out of reach of children, pets, and people unaware of their own actions.
- For proper disposal of packaging, comply with local legislation.
- Make sure that the electrical values indicated on the rating plate correspond to those of the network to which the appliance is to be connected and that the socket conforms to the plug of the appliance.
- Make sure that the power cable is always fully unwound when using the vacuum cleaner.
- Do not touch/use the plug and vacuum cleaner with wet hands.
- Do not vacuum materials that may damage the filter elements (e.g. glass debris, metal, etc.).
- Never pull or lift the appliance using the electrical cable.
- Do not immerse the appliance in water to clean it, nor wash it with water jets.
- Do not use the appliance at a height greater than 2000 m.

- This appliance is not suitable for collecting hazardous dust.
- Do not vacuum incandescent, flammable, explosive or toxic substances/mixtures. The maximum permissible operating temperature is 40°C (104°F).

**Any use other than those indicated in this manual may be a hazard, so it should be avoided.**

**Do not leave the appliance unattended while it is operating, always remove the plug from the socket when it is no longer in use and, in any case, keep it out of the reach of children or people who are not aware of their actions.**

- The device must be used, mounted, stored and transported on a stable and safe surface, not inclined.
- This appliance must be stored, taking into account its weight, on a stable and safe surface, not inclined and only in closed and moisture-free places.
- Never direct the suction port at parts of the body of people or animals - e.g. eyes, ears, mouth, etc. This can be very dangerous.
- Use only the accessories supplied with the appliance or possibly those specified in the instruction manual. Using different accessories can compromise safety.
- The device is not suitable for environments in which electrostatic discharge or sparks can cause damage to electrical components or people.

**Any modification of the device is prohibited. Fraudulent handling of the vacuum cleaner not only results in the cancellation of the manufacturer's warranty certificate, but can also cause fire or injury, even death, to the user.**

**The manufacturer accepts no liability for damage to persons or property caused by failure to follow these instructions or if the appliance is used unreasonably.**

- In the event of a foam or liquid leak, turn off the engine.
- In the event of a rollover, it is advisable to lift it before turning off the engine.
- Do not suck water from containers, sinks, bathtubs, etc.
- Do not use or vacuum harsh detergents as they may damage the appliance.

**The level sensor (float) is used to stop suction when the drum is full of liquid or in the event of a spill; Clean it regularly, also checking it for damage and replace it if necessary.**

- This appliance cannot be used outdoors or in low temperature conditions.

## 4 Machine data

### 4.1 Machine Description

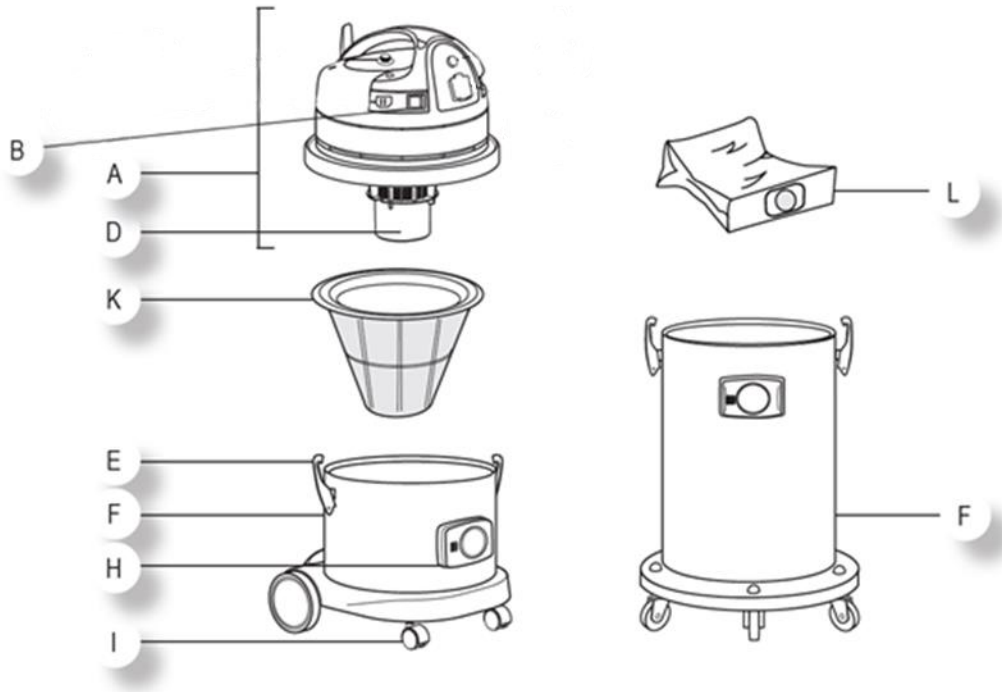

Has	Head
B	Switch
D	Float: it prevents the suction liquid from invading the engine block
E	Hooks for clamping the engine block on the drum
F	Barrel
H	Suction nozzle
I	Swivel wheels
K	Polyester filter inserts into the drum to suck up dust and removes to suck up liquids
L	Filter bag to be applied directly to the suction nozzle. Its use does not exclude the use of the polyester filter, which must still be used.



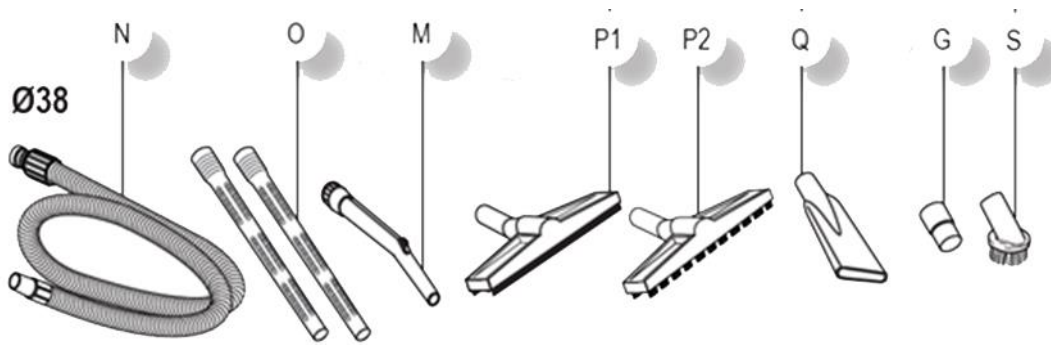

M	Handful
N	Hose
O	Tube
P1	Suction cup brush
P2	Dust brush
Q	Flat Lance
S	Brush Brush
G	Reduction

#### 4.2 Technical data

Model	<b>HP 430 P 230V WD 70184632736</b>	<b>CV 430 P 110V WD 70184632994</b>	<b>CV 430 I 230V WD 70184632741</b>	<b>CV 430 I 110V WD 70184633140</b>
Power	2400 W (2 motors)	2400 W (2 motors)	2400 W (2 motors)	2400 W (2 motors)
Voltage	230 V – 50 Hz	110 V – 60 Hz	230 V – 50Hz	110 V – 60Hz
Cleaning the filter	Manual			
Debit	420 m <sup>3</sup> /h	422 m <sup>3</sup> /h	420 m <sup>3</sup> /h	422 m <sup>3</sup> /h
Depression	247 mBar	256 mBar	247 mBar	256 mBar
Tank Material	Plastic		Stainless steel	
Usable Capacity	90 l		62 l	
Size	676 x 568 x 911 mm			
Suction diameter	Ø 50 mm			
Weight	30 kg			
Sound Pressure Level	73.1 dB			

### **4.3 *Machine insert***

Each Saint-Gobain Norton Clipper machine carries an identification plate with the essential details needed to contact the supplier/manufacturer for advice, suggestions, or aftermarket information.

The following details can be found on the plaque:

- Maker
- Model
- Serial Number
- Supply voltage
- Nominal installed power
- CE symbol (manufactured in accordance with the Machinery Directive 2006/42/EEC) and UKCA

## **5 Performance Tolerances**

The performance of the turbine can vary by 15% depending on the temperature and humidity of the air.

The safety valves are calibrated according to the amperage of the turbine.

## 6 Using the vacuum cleaner

### 6.1 Dust extraction / instructions for use

- Insert the polyester filter into the drum

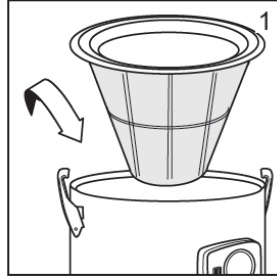

- Mount the head on the drum and secure it with the hooks

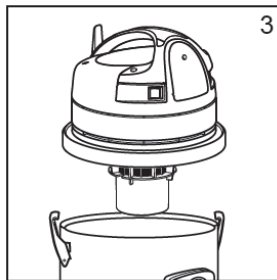

- Insert the hose into the nozzle

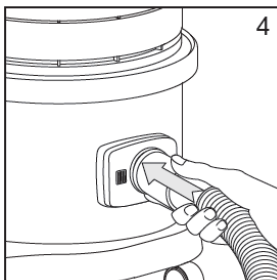

- At the end of the hose, insert the handle and extensions. Choose and connect the most suitable accessory.

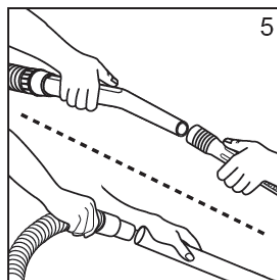

- Turn on the appliance after plugging the plug into an outlet

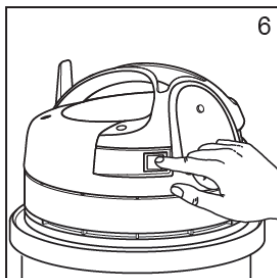

## 6.2 Liquid suction / instructions for use

- Remove the polyester filter from the drum (Fig. 2)

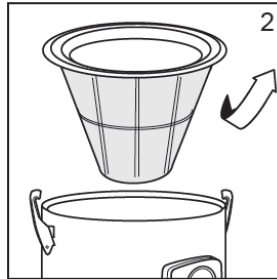

- Mount the head on the drum and secure it with the hooks (Fig. 3)

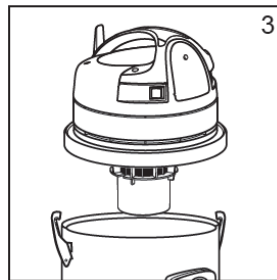

- Insert the hose into the nozzle (Fig. 4)

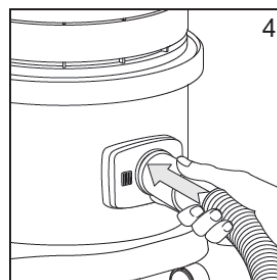

- At the end of the hose, insert the handle and extensions (Fig. 5)

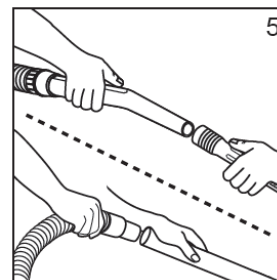

- Connect the suction cup brush -P1-.
- Turn on the appliance after plugging the plug into an outlet (Fig.6)

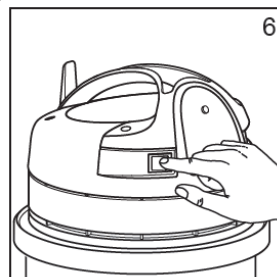

## 7 Maintenance

**Always remove the plug from the socket before carrying out any type of intervention. After each use and before sending the appliance for service, clean each of its parts to avoid any risk.**

- In order to ensure safe and continuous operation, periodically perform regular maintenance, including checking the integrity of the plastic parts, the filter kit, the tightness of the gaskets and the proper functioning of the control mechanism.
- Check the power cable regularly to make sure there are no nicks, abrasions, cracks, or signs of aging. Replace the cable before using it later.
- Replacement of the damaged cable must be carried out by the technical support service or by competent personnel authorized by a recognized qualification.
- When using extension cords, make sure that they have at least the same cross-section as the power cable and that they do not come into contact with liquids or conductive surfaces.
- Cleaning should not be done by children unsupervised.
- Maintenance and repair operations must always be carried out by personnel authorized by the Manufacturer or by a recognized certification; Any defective parts should only be replaced with original replacement parts.
- In order to maintain the perfect efficiency of the device for dust extraction, the polyester filter must be cleaned by shaking it after each use and the filter bag should be replaced when it is full.
- Clean the entire appliance after use; Empty the tanks, shake the filters, replace the bag if it is full, and wipe the surfaces with a damp cloth before storing it.

## 8 End of Product Life

Dispose of the machine and all accessories in accordance with the country's legislation.

To avoid harming the environment or your or others' health, it is recommended that you separate the machine from other waste and, if necessary, recycle it properly.

## 9 Breakdowns – Cause and Repair

### 9.1 Fault Tracking

PROBLEM	CAUSE	MEDICINE
Engines won't start.	No electrical voltage.	Check the cables, plugs, and plug.
The suction capacity slowly decreases.	The filter, nozzle, suction hose or suction hose may be blocked.	Check and clean accessories. Clean the filter.
Dust comes out during vacuuming.	The filter has not been properly secured or is defective.	Check if the filter is installed correctly; replace it if necessary.

### 9.2 After-sales service

When ordering spare parts, always indicate:

- Serial number (seven digits)
- Part Number
- Exact description
- Number of pieces desired
- Exact address
- Please avoid statements such as "as soon as possible" or "urgent" but clearly indicate the desired shipping method: "express", "by air", etc.

If you do not specify the desired shipping method, we will send the parts by the means considered the most reasonable, without necessarily being the fastest.

With accurate instructions, you will avoid problems and shipping errors.

If there is any uncertainty, please send us the defective part.

**In the event that the parts are covered by the warranty, the shipment of the defective part is mandatory.**

Order engine parts directly from the manufacturer or from a representative – you'll save time and money!

This machine was manufactured by Saint-Gobain Abrasives S.A.:

190 J. F. Kennedy Blvd.  
L-4930 BASCHARAGE  
Grand Duchy of Luxembourg  
Tel.: 00352 50 401 1  
Fax. : 00352 50 16 63  
<http://www.construction.norton.eu>  
E-mail: [sales.nlx@saint-gobain.com](mailto:sales.nlx@saint-gobain.com)

### 9.3 Parts

To view spare parts lists, please visit the Norton Clipper Aftermarket website at the following address:

<https://spareparts.nortonabrasives.com>

For quick access, you can also use the QR Code below using your mobile phone:



This electronic catalog provides you with exploded parts and spare parts lists for various Norton Clipper machines so that you can find the part numbers you need.

You can get technical support, spare parts and diamond blades from our local distributors.

SAINT-GOBAIN ABRASIVES  
INDUSTRIEWEG 21  
9420 ERPE-MERE  
BELGIUM  
TEL: +32(0) 2 267 21 00

SAINT-GOBAIN CONSTRUCTION  
PRODUCTS CZ A.S  
DIVIZE ABRASIVES  
SMRČKOVA 2485/4  
180 00 PRAHA 8  
TEL: +420 255 719 326 FAX: +420 255 719 321

SAINT-GOBAIN ABRASIVES A/S  
DYBENDALSVÆNGET 2,  
DK-2630 TAASTRUP  
DENMARK  
TEL: +45 4675 5244

PO BOX 643706  
FORTUNE TOWER OFFICE 2106  
JLT BLOCK C  
(NEXT TO METRO STATION)  
JUMEIRA LAKE TOWER, DUBAI  
UNITED ARAB EMIRATES  
TEL: +971 4 431 5154  
FAX: +971 4 431 5434

SAINT-GOBAIN ABRASIVES  
RUE DE L'AMBASSADEUR - B.P.8  
78 702 CONFLANS CEDEX  
FRANCE  
TEL: +33 (0)1 34 90 40 00  
FAX: +33 (0)1 39 19 89 56

SAINT-GOBAIN ABRASIVES GMBH  
BIRKENSTRASSE 45-49  
D-50389 WESSELING  
GERMANY  
TEL: +49 (0) 2236 703-0  
FAX: +49 (0) 2236 703-730

SAINT-GOBAIN KFT ABRASIVES.  
1225 BUDAPEST  
BÁNYALÉG U. 60/B.  
HUNGARY  
TEL: +36 1 371 22 50  
FAX: +36 1 371 22 55

SAINT-GOBAIN ABRASIVI S.P.A  
VIA PER CESANO BOSCONI 4  
I-20094 CORSICO MILANO  
ITALY  
TEL: +39 02 44 851  
FAX: +39 02 44 78 266

SAINT-GOBAIN ABRASIVES S.A.  
190 J.F. KENNEDY STREET  
L-4930 BASCHARAGE  
GRAND DUCHY OF LUXEMBOURG  
TEL: +352 50 401 1  
FAX: +331 83 717 792  
NO. VERT (FRANCE): 0800 906 903

SAINT-GOBAIN ABRASIVES, S.A.  
2 ALLÉE DES FIG TREES  
AIN SEBAË - CASABLANCA  
MOROCCO  
TEL: +212 5 22 66 57 31  
FAX: +212 5 22 35 09 65

SAINT-GOBAIN ABRASIVES BV  
GROENLOSEWEG 28  
7151 HW EIBERGEN  
P.O. BOX 10  
7150 AA EIBERGEN  
THE NETHERLANDS  
TEL: +31 545 466466  
FAX: +31 545 474605

SAINT-GOBAIN ABRASIVES AS  
KARIHAUGVEIEN, 89  
0186 OSLO  
NORWAY  
TEL: +47 63 87 06 00  
FAX: +47 63 87 06 01

SAINT-GOBAIN HPM POLSKA SP. Z O.O.  
UL. NORTON 1, 62-600 KOŁO  
62-600 KOŁO  
POLAND  
TEL: +48 63 26 17 100  
FAX: +48 63 27 20 401

SAINT-GOBAIN ABRASIVOS, L. DA  
ZONA INDUSTRIAL DA MAIA I-SECTOR  
VIII, NO. 122  
APARTADO 6050  
4476 - 908 MAIA  
PORTUGAL  
TEL: +351 229 437 940  
FAX: +351 229 437 949

SAINT-GOBAIN GLASS  
BUSINESS UNIT ABRASIVI  
PUNCT DE LUCRU : LOC. VETIS, JUD.  
SATU MARE 447355  
STR. CAREIULUI 11  
INDUSTRIAL PARK RENOVATIO  
ROMANIA  
TEL: +40 261 839 709  
FAX: +40 261 839 710

SG HPM RUS  
58, F. ENGELS STR.  
STROENIE 2  
105082 MOSCOW  
RUSSIA  
TEL: +74 955 408 355  
FAX: +74 959 373 224

SAINT-GOBAIN ABRASIVES (PTY) LTD  
2 MONTEER ROAD  
ISANDO 1600  
P.O. BOX 67  
SOUTH AFRICA  
TEL: +27 11 961 2000  
FAX: +27 11 961 2184/5

SAINT-GOBAIN ABRASIVOS, S.A.  
CTRA. FROM GIPIZKOA, KM. 7,5  
E-31195 BERRIOPLANO (NAVARRA)  
SPAIN  
TEL: +34 948 306 000  
FAX: +34 948 306 042

SAINT GOBAIN ABRASIVES AB  
GÅRDSFOGDEVÄGEN 18A  
168 66 BROMMA • SVERIGE  
SWEDEN  
TEL: +46 8 580 881 00  
FAX: +46 8 580 881 30

SAINT-GOBAIN INOVATIF MALZEMELER  
VE ASINDIRICI SAN. TWITCH. ACE.  
ALTAYÇEŞME MAH. ÇAMLI SOK. NO:21  
ESAS OFISPARK KAT:9 34843  
MALTEPE, İSTANBUL • TURKEY  
TEL: 0090-216-217 12 50  
FAX: 0090-216-442 40 74

SAINT-GOBAIN ABRASIVES LTD.  
UNICORN HOUSE UNIT 1, AMISON CLOSE  
REDHILL BUSINESS PARK  
STAFFORD ST161WB  
UNITED KINGDOM  
TEL: +44 1785 279 553  
FAX: +44 1785 213 487



Saint-Gobain Abrasifs  
190 Rue J.F. Kennedy  
L-4930 Bascharage  
Grand Duché de Luxembourg  
Tel: +352 50 4011  
Fax: +331 83 717 792  
no. vert (France) 0800 906 903

[www.nortonabrasives.com/fr-fr](http://www.nortonabrasives.com/fr-fr)