

CS 451 D7

OPERATING INSTRUCTIONS

Translation of the original instructions



clipper®



CE Declaration of conformity

The undersigned manufacturer:

SAINT - GOBAIN ABRASIVES S.A.
190, BD. J. F. KENNEDY
L-4930 BASCHARAGE

Declares that this product:

« Floor saw »: **CS 451 D7**

Code : **70184629089**

is in conformity with the following Directives :

- **"MACHINES" 2006/42/CE**
- **"ELECTROMAGNETIC COMPATIBILITY" 2004/108/CE**
- **"NOISE" 2000/14/CE**

And the European standard:

- **EN 13862 – Floor cutting-off machines – Safety**

Valid for machines as of serial number:

70100000

Storage site for the technical documents:

Saint-Gobain Abrasives 190, Bd. J. F. Kennedy 4930 BASCHARAGE, LUXEMBOURG

This declaration of conformity loses its validity when the product is converted or modified without agreement.

Bascharage, Luxembourg, 01/02/2012.

Olivier Plenert, executive officer.

CS 451 D7

OPERATING INSTRUCTIONS

<u>1</u>	<u>BASIC SAFETY INSTRUCTIONS</u>	<u>6</u>
1.1	<i>Symbols</i>	6
1.2	<i>Machine plate</i>	7
1.3	<i>Safety instructions for particular operating phases</i>	8
<u>2</u>	<u>GENERAL DESCRIPTION OF THE CS 451</u>	<u>9</u>
2.1	<i>Short description</i>	9
2.2	<i>Layout</i>	10
2.3	<i>Technical data</i>	12
2.4	<i>Statement regarding the vibration emission</i>	13
2.5	<i>Statement regarding noise emission</i>	14
<u>3</u>	<u>ASSEMBLY AND COMMISSIONING</u>	<u>15</u>
3.1	<i>Operator's handle assembly</i>	15
3.2	<i>Tool assembly</i>	15
3.3	<i>Water cooling system</i>	15
3.4	<i>Starting the machine</i>	16
<u>4</u>	<u>TRANSPORT AND STORING</u>	<u>17</u>
4.1	<i>Securing for transport</i>	17
4.2	<i>Transport and lifting procedure</i>	17
4.3	<i>Long period of inactivity</i>	17
<u>5</u>	<u>OPERATING THE CS 451</u>	<u>18</u>
5.1	<i>Site of work</i>	18
5.2	<i>Cutting method</i>	18
<u>6</u>	<u>MAINTENANCE AND SERVICE</u>	<u>20</u>
6.1	<i>Maintenance of the machine</i>	20
6.2	<i>Maintenance of the engine</i>	21
<u>7</u>	<u>Breakdowns: causes and cures</u>	<u>26</u>
7.1	<i>Breakdown-finding procedures</i>	26
7.2	<i>Trouble-shooting guide</i>	26
7.3	<i>Customer service</i>	27

1 BASIC SAFETY INSTRUCTIONS

The CS 451 is exclusively designed for the cutting of floors made of asphalt, green and cured concrete (reinforced or not) as well as of industrial cement.

Uses other than the manufacturer's instructions shall be considered as contravening the regulations. The manufacturer shall not be held responsible for any resulting damage. Any risk shall be borne entirely by the user. Observing the operating instructions and compliance with inspection and servicing requirements shall also be considered as included under use in accordance with the regulations.

1.1 Symbols

Important warnings and pieces of advice are indicated on the machine using symbols. The following symbols are used on the machine:



Read operator's instructions



Ear protection must be worn



Hand protection must be worn



Eye protection shall be worn

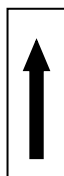

Cutting depth indicator



Danger: risk of cut

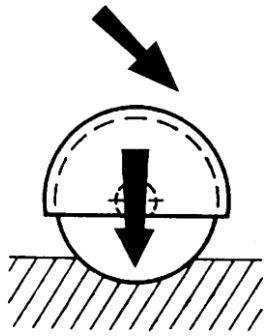

Rotation of the wheel in the indicated direction lowers the blade

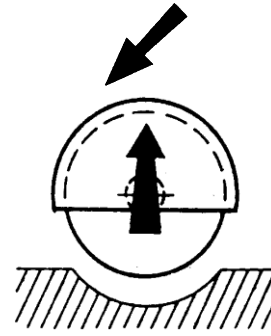

Rotation of the wheel in the indicated direction raises the blade

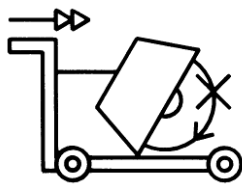

Never move the machine with the blade running idle.



Rotation direction of the blade

1.2 Machine plate

Important data can be found on the following plate located on the machine:

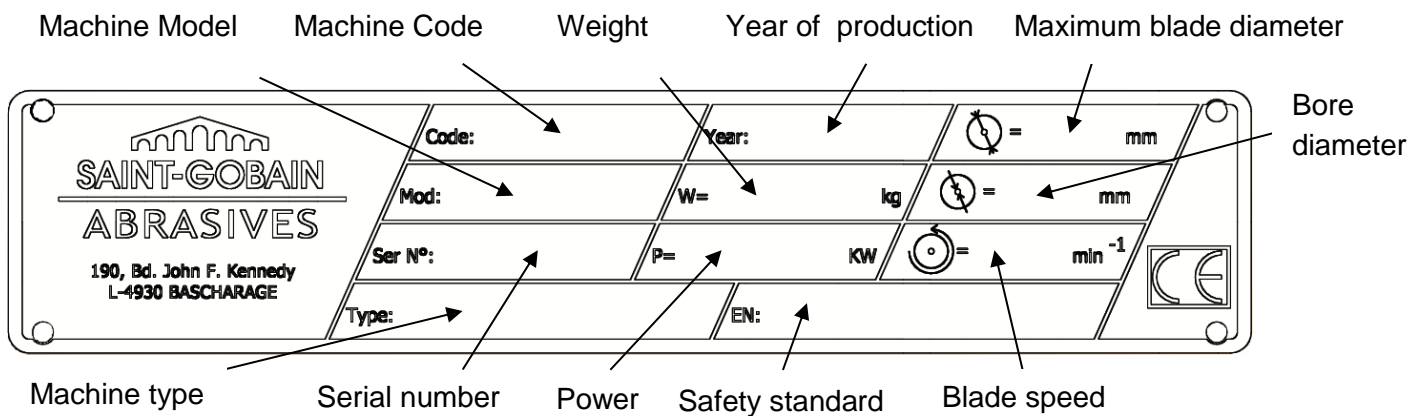

1.3 Safety instructions for particular operating phases

Before commencing work

- Before commencing work, make yourself familiar with the working environment at the place of use. The working environment includes: obstacles in the area of work and manoeuvre, the firmness of the floor, necessary protection at the site relating to public thoroughfares and the availability of help in the event of accidents.
- Check for correct mounting of the blade regularly.
- Immediately remove damaged or badly worn blades, as they endanger the operator whilst rotating.
- Always cut with the blade guard in position.
- Only fit NORTON diamond blades to the machine! The use of other tools can damage the machine!
- Read the blades' specifications carefully to choose the correct tool for your application.
- Attention is drawn to the use of BS2092 safety goggles in conformity with specified Processes No.8 of the Protection of Eyes Regulation 1974, Regulation 2(2) Part 1. Also use the other safety equipments mentioned on the symbols and a dust mask when you are dry cutting.
- For security reasons, never leave the machine unattended, untied or unlocked.

While the engine is running

- Do not move the machine whilst the blade is running idle.
- Do not run the machine without the security guards in place.
- Apply cooling water continuously whilst cutting and in good time (even while dry cutting to avoid excessive dust)!

Petrol powered machines:

- Always use the fuel advised.
- In confined areas, exhaust gases should be evacuated and the job site properly aerated.
- Petrol and diesel machines, which by their nature emit toxic exhaust gases, must not be used in places prohibited by the Health at Work etc. Act 1974 or which are prohibited by Factory Inspectors or Safety Officers.
- Fuel is flammable. Before filling the tank, shut down the engine, extinguish all open flames and do not smoke. Take care that no fuel is spilled on any motor part. Always wipe up spilled fuel.

2 GENERAL DESCRIPTION OF THE CS 451

Any modification, which could lead to a change in the original characteristics of the machine, may be done only by Saint-Gobain Abrasives S.A. who shall confirm that the machine is still in conformity with the safety regulations. Saint-Gobain Abrasives S.A. keeps the right of making technical or design modification without prior notification.

2.1 *Short description*

The **Floor Saw CS 451** you have chosen is used for small repair works in concrete and asphalt, for cutting induction loops and installing cables as well as for cutting expansion joints. It can be used either for wet or dry cutting operations.

The optimized weight distribution and the position of 25 litre water container ensure outstanding cutting performance as well as easy handling.

Specific machine parts allow continuously setting the cutting depth and easily keeping the desired cutting direction.

Ergonomic handles can be set at right height independently from the cutting depth; handles feature a built-in vibration absorbing device. Reinforced frame reduces vibration level and therefore operator's fatigue.

The **CS 451** has taper lock pulleys and a Poly-V belt for better reliability and easy maintenance.

Being of small construction, it can be transported in a car or van; the handle can be removed, reversed or retracted. The 25 litre water container is also removable.

All components on the **CS 451** are assembled to a high quality standard, ensuring long life, reliability and a minimum of maintenance.

Special types of blades are available for asphalt, green concrete, cured concrete (reinforced or not) as well as for industrial cement flooring.

2.2 Layout

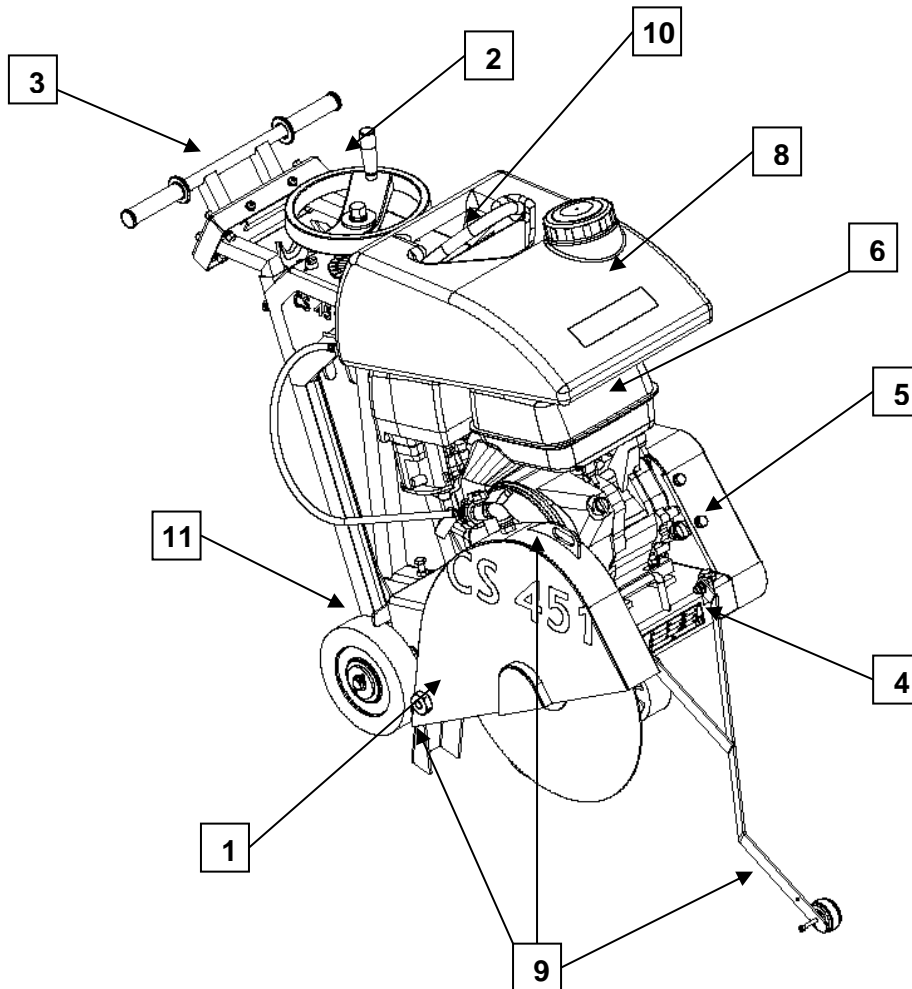

Made of jig welded open profile steel, the **CS 451** is stable but at the same time, easily transportable.

The one-piece blade guard (1) fully protects the operator and his working environment. It is firmly fixed to the main frame but can be opened by rotation to change blades.

A manually operated hand wheel mechanism (2) enables graduated depth setting. Turning the hand wheel clockwise or anti-clockwise will lower or raise the cutting blade. A depth gauge allows the operator to control precisely the depth of cut.

The handle (3) is removable or can be reversed for easy transportation. The height is adjustable independently from the cutting depth. A specific built-in device reduces vibrations.

The machine frame is also designed to reduce vibrations, improving work conditions.

The pivoting frame (4), hinged on the rear axle, is supporting the engine, the blade shaft assembly, and the protecting guards. A **Poly-V** belt drives the blade.

The precisely manufactured blade shaft is fitted into two heavy-duty self-aligning pillow block bearings, including grease nipples. On one end, a Poly-V pulley with taper lock fixing is assembled. On the other end, the shaft is reduced to 25,4mm, allowing an inner flange to be fixed. Outer flange is assembled on the shaft with a 36mm locking nut.

(A 20 mm thick spacer and an outer flange, with dowel pinholes, can be provided as accessories)

The steel belt guard (5) is a sealed two piece unit. The backing plate is bolted to the mainframe of the machine and locking nuts are welded to it. The outer guard, covering the Poly-V belt and taper lock pulleys, is held in place by four locking bolts.

The HATZ 1B30 diesel engine (6) is started using a recoil starter. The following picture is showing the different parts of your engine that you need to know in order to use and maintain your machine correctly:

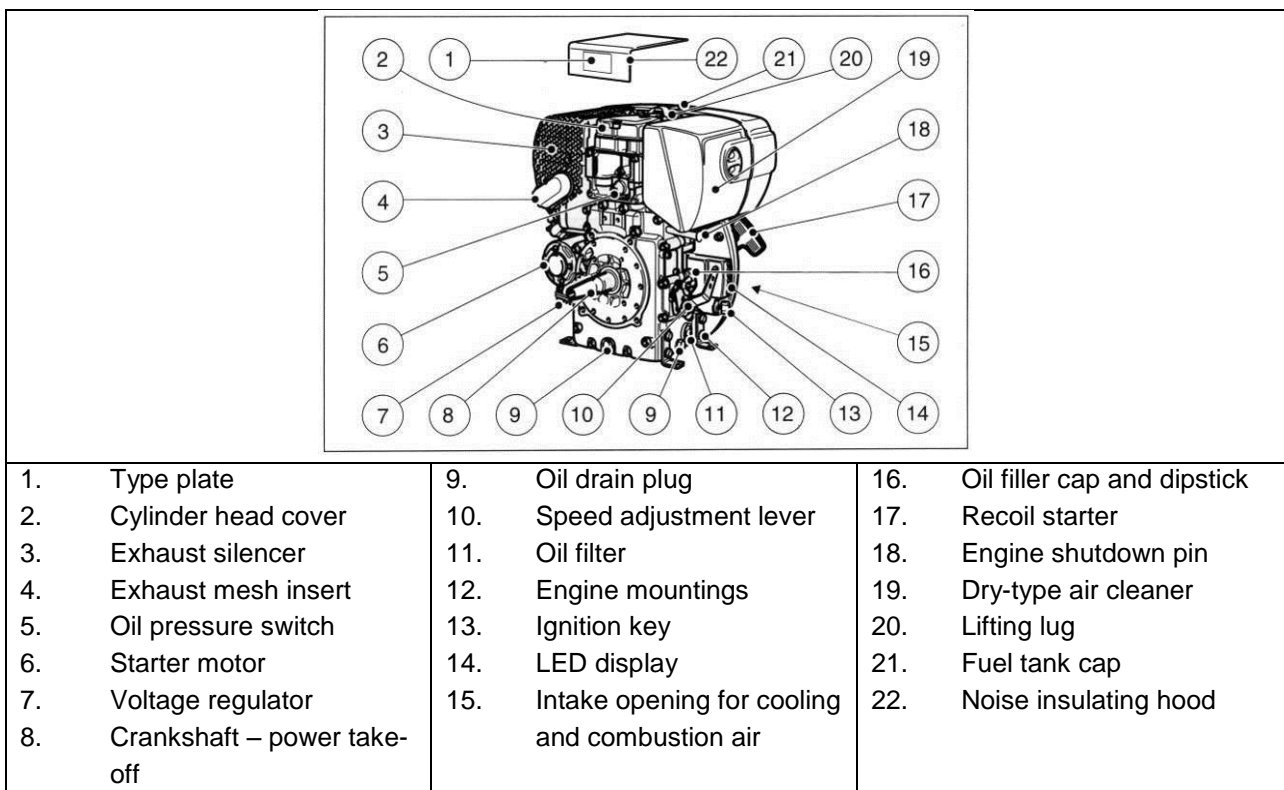

The water cooling system (8) is composed of a 25-litre water tank, a water tank cock and two water nozzles located on the blade guard ensuring adequate flow of water to both sides of the cutting blade. This system can also be connected directly to tap water.

The pointers (9) allow the operator to make precise cut easily. It is composed of a front cutting guide, a sight welded on the blade guard and rear guide assembled on the back of the blade guard. The combination of these 3 devices allows easy and accurate alignment of the blade with cutting line.

A hook (10) allows the CS 451 to be lifted easily, safely, and in a balanced way.

Parking brake (11) secures the machine when it is not running.

2.3 Technical data

Engine	Hatz 1B30, 7HP (5kW)
Fuel	Diesel complying with the following minimum specifications : EN590 or DIN15601 – DK or BS 2869 A1/A2 or ASTM D975 – 1D / 2D
Oil	Oil complying with the following minimum specifications: CCMC – D4 – D5 – PD2 or API – CD – CE – CF – CG or SHPD Viscosity recommended : SAE 10W-30 (outside temperature between - 5°C and 35°C)
Starter	Manual pull cord
Max. blade diameter	450 mm
Bore	25,4 mm
Max. cutting depth mm	170 mm
Flange diameter	108 mm
Blade shaft speed	2573 min ⁻¹
Driving belt	Poly-V 698PK10
Water tank	25 l
Machine dimensions (length x width x height)	1180 x 538 x 1040 mm in cutting configuration
Weight	120 kg
Max. operating weight	153 kg
Sound pressure level	91 dB (A) (ISO EN 11201)
Sound energy level	110 dB (A) (ISO EN 3744)
Vibration emission value	4,7 m/s ² (according to EN 12096)

2.4 Statement regarding the vibration emission

Declared vibration emission value in accordance with **EN 12096**

Machine Model / code	Measured vibration emission value a m/s ²	Uncertainty K m/s ²	Tool used Model / code
CS 451 D7 70184629089	4,7	0,5	ZML 3270 NS Ø450x25.4

- Values determined according to the procedure described in annex F of **EN 13862**
- Measurements are made with new machines. Actual values on site could vary dramatically (the simple one with the double) according to operating conditions, like :
 - Material to be cut
 - Cutting depth
 - Wear of the machine
 - Lack of maintenance
 - Tool not adapted to application
 - Tool in bad shape
 - Non-specialised operator
- Exposure time to vibrations also depends on cutting performance (adequacy machine / tool / material to cut / operator)
- To evaluate risks due to hand-arm vibrations, you also need to take into account the effective usage at full power of machine during a full day of work. In most case, you will realise it represents around 50% of the overall duration of work when you remove breaks, refilling of water and fuel tanks, preparation of work, time to move the machine on site, blade assembling...

2.5 Statement regarding noise emission

Declared value of noise emission following **EN ISO 11201** and **NF EN ISO 3744**.

Machine Model / code	Sound Pressure level L_{Peq} EN ISO 11201	Uncertainty K (Sound Pressure level L_{Peq} EN ISO 11201)	Sound power level L_{Weq} NF EN ISO 3744	Uncertainty K (Sound power level L_{Weq} NF EN ISO 3744)
CS 451 D7 70184629089	91 dB(A)	2.5 dB(A)	110 dB(A)	4 dB(A)

- Values determined using the procedure described in the standard **EN 13862**.
- The measurements are made with new machines. Actual values may vary with site conditions, in terms of:
 - Wear Machine
 - Lack of maintenance
 - Inappropriate tool for application
 - Tool in poor condition
 - Unskilled operator
 - Etc...
- Measured values relate to an operator in normal use, as described in the manual position.

3 ASSEMBLY AND COMMISSIONING

Before beginning the work with the CS 451, you have to assemble some parts.

3.1 *Operator's handle assembly*

Secure the operator's handle in a comfortable user position by using the locking screws.

3.2 *Tool assembly*

Only NORTON blades with a maximum diameter of 450 mm can be fitted on the CS 451.

All tools used must be selected with regard to their maximum permitted cutting speed for the machine's maximum permitted rotation speed.

Before mounting a new blade, switch the machine off.

To mount a new blade, follow these steps:

- Turn the hand wheel until the pivoting frame is in the raised position.
- Loosen the screw maintaining the guard and turn the blade guard open.
- Loosen the hexagonal nut (**careful:** left hand thread) on the blade shaft, which holds the removable outer flange. Remove the nut and the outer flange. Remove the nut and the outer flange.
- Clean the flanges and blade shaft and inspect for wear.
- Mount the blade on the shaft ensuring that direction of rotation (arrow on blade steel centre) is correct. Wrong direction of rotation blunts the blade quickly.
- Put the outer blade flange back in place.
- Tighten the hexagonal nut with the 36mm spanner supplied for this purpose (left hand thread).
- Close the blade guard and tighten the maintaining screw.

ATTENTION! The blade bore must correspond exactly to the blade shaft. Cracked or damaged bore is dangerous for the operator and for the machine.

3.3 *Water cooling system*

- Fill in the water tank with clean water.
- Open the cock on the water tank (note that handle of the water cock should be in line with the flow).
- Ensure that water is flowing freely in the circuit and delivered adequately to both sides of the blade, as insufficient water supply may result in premature failure of the diamond blade or excessive dust generation.
- If needed, adjust water flow with blade guard water cock.
- In case of frost, empty the water cooling system.

3.4 Starting the machine

Make sure the blade is raised clear up the ground before starting the machine.

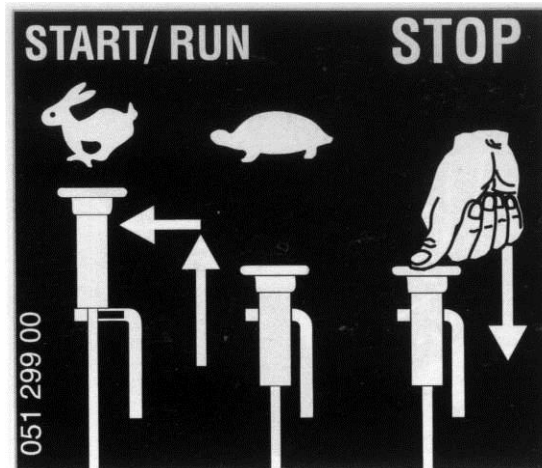

Set the speed adjuster to the STOP position, then move it to the START/RUN position, by pulling the knob and stick it on the metal part. Never use starting sprays.



Pull the starting cable out by the handle until you feel a slight resistance. Let the cable run back; in this way the entire length of the starting cable can be used to start the machine. .

Grip the handle with both hands. Commence pulling the starting cable vigorously and at an increasing speed (do not jerk it violently) until the engine starts.

If after several attempts of starting the exhaust begins to emit white smoke, move the speed adjustment lever to the STOP position and pull the starting cable out slowly 5 times. Then repeat the starting procedure.

To stop the machine, set the speed adjuster knob to the STOP position, and press it until the engine cuts out.

4 TRANSPORT AND STORING

Take the following measures in order to transport and store the CS 451 securely.

4.1 Securing for transport

Before transporting the machine:

- Remove the blade.
- Empty the water tank.
- Lower handles in its fixing tube and secure it using the locking screws.
- Raise the front guide in its upright position.
- Raise the pivoting frame to its highest position using the hand wheel, in order to activate the parking brake.

4.2 Transport and lifting procedure

The machine can be moved on a flat surface using its wheels. Only use the metal hook located over the water tank to lift the machine with a crane.

No other part (e.g. handles) is dimensioned to lift the machine. It is therefore absolutely prohibited to do so.

4.3 Long period of inactivity

If the machine is not going to be used for a long period, please take the following measures:

- Completely clean the machine.
- Loosen the drive belt.
- Grease the threaded shaft.
- Possibly change the engine oil.
- Empty the water system.
- Activate the parking brake by raising the cutting head.

The storage site must be clean, dry and at a constant temperature.

5 OPERATING THE CS 451

5.1 *Site of work*

Before you start working, please check the following points:

- Remove from the site anything, which might hinder the working procedure.
- Make sure the site is sufficiently well lit.
- If water hoses are used, place them so that they cannot be damaged.
- Make sure you have a continual adequate view of the working area so you can intervene in the working process at any time.
- Keep other staff out of the area, so you can work securely.

5.2 *Cutting method*

In this section, you can find instructions on how to make a straight cut at the desired depth.

5.2.1 Preparing your cut

Before starting the machine,

- Draw a line on the floor over the cutting length.
- Make sure that you have filled the engine tank with fuel, and the water tank with water, or, when possible, that the machine is connected to the water network. No fuel is supplied with the machine.
- The engine is shipped with oil. Check oil level before starting. Top up if required.
- Make sure you have assembled the correct blade as recommended by the manufacturer depending on the material to be cut, the working procedure (dry or wet cut) to be carried out, and the efficiency required.
- Make sure that the flanges securely hold the diamond blade.
- Make sure that the blade is not touching the floor before starting; turn the hand wheel up to the mechanical stop.
- Adjust the handle to a comfortable position.
- Roll the machine until the blade is over the line.
- Lower the front guide so it touches the line.
- Align the front cutting guide, the sight welded on the blade guard and the rear cutting guide with the line.

5.2.2 Cutting the floor

You can now start the engine.

To make your cut,

- Turn the depth hand wheel until the blade slightly touches the floor.
- Open water valve to control the amount of water required for the type of blade, using 15 to 25l/min for wet cutting and 1-2l/min for dry cutting (dust control). Check for minimum water level regularly when using the water tank.
- To lower blade into the cut, turn hand wheel clockwise. Each turn of the hand wheel will raise or lower the blade by 10mm. To prevent the blade to rise with vibrations, you can use the hook on the main panel to lock the hand wheel.
- Once the required depth of cut is reached, push the machine forward with steady and gentle pressure and follow the line with the cutting guides. The feed speed must be adjusted depending on the material being cut, and the depth of cut.
- At the end of the cut, raise the blade out of the cut by turning the hand wheel anti-clockwise, shut-off the water and switch off the engine.

6 MAINTENANCE AND SERVICE

CAUTION: to perform maintenance of the machine, always switch it off. Always wear a mask and safety goggles while performing the maintenance of machine.

6.1 Maintenance of the machine

To ensure a long-term quality from the cutting with the CS 451, please follow the maintenance plan below:

		Regular service period Perform at every indicated period →						
		After one hour of work	Beginning of the day	During tool change	End of the day	Once a week	After a failure	After a damage
Whole machine	Visual control (general aspect, sealing)							
	Clean							
Flange and blade fixing devices	Clean							
Belt tension	Control							
Water hoses and nozzles	Clean							
Depth screw	Grease							
Engine housing	Clean							
Reachable nuts and screws	Tighten up							

Adjustment and replacement of the belt

After one hour of work, the belt heats up and stretches. Therefore, you have to re-tighten it.

To adjust the belts, firstly remove the belt guard by unscrewing the 4 screws. Loose the screw maintaining the tensioning device with the 17mm wrench. You can know re-tension using a 36mm wrench to turn the tensioning device. Retighten the maintaining screw, and re-assemble the belt guard.

To replace the belts, loose the screw maintaining the tensioning device and turn the tensioning device in order to release the belt. Adjust the belts and retighten them by moving the tensioning device back on the belt with the 36mm wrench then retighten the maintaining screw of the tensioning device.

Lubrication

The CS 451 uses life-lubricated bearings. Therefore, you don't need to lubricate them at all. Grease the depth screw once a week.

Cleaning of the machine

Your machine will last longer if you clean it thoroughly after each working day.

6.2 Maintenance of the engine

		Regular service period Perform operating hour interval →				
		Each use	First month or 25 hours	Every 250 hours	Every 500 hours	Every 1000 hours
Engine oil	Check level					
	Change					
Oil filter	Clean					
Cooling air zone	Check-Clean					
Air intake point	Check-Clean					
Water trap	Check					
Air cleaner filter	Clean					
	Change the cartridge					
Valve clearance	Check and adjust					
Fuel filter	Replace					
Exhaust mesh inlet	Clean					

Oil level check

When checking the oil level, the engine must not be running, and should stand horizontal.

- Remove any dirt in the dipstick area.
- Check oil level at the dipstick: top up if necessary as far as the max. mark.

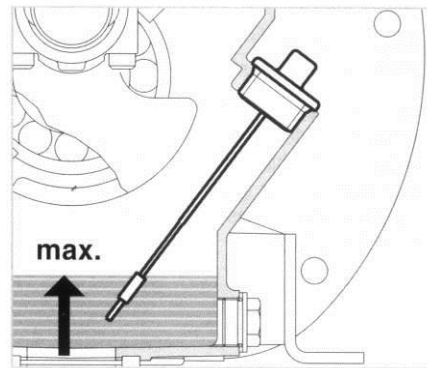

Changing engine oil

The engine must be stopped, and should stand horizontal. Drain the engine oil when it is warm. **CAUTION!** Risk of scalding from hot oil.

Please dispose of used motor oil in a manner that is compatible with the environment. We suggest you to take used oil in a sealed container to your local recycling centre or service station for reclamation. Do not throw it in the trash, pour it on the ground or down in a drain.

- Take out the oil drain plug « 1 » and allow the oil to drain out.
- Clean the oil drain plug « 1 » and fit a new washer « 2 » before tightening. (Tightening torque : 50 Nm)
- Add engine oil until the max. mark on the dipstick.

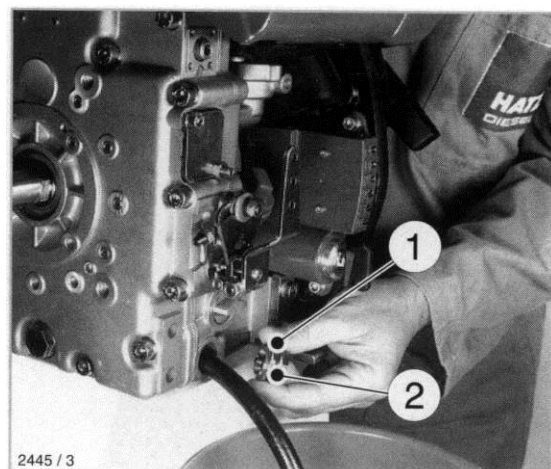

Cleaning the oil filter

The oil filter should be cleaned at the same time as the engine oil is changed, since oil escapes when the filter is removed.

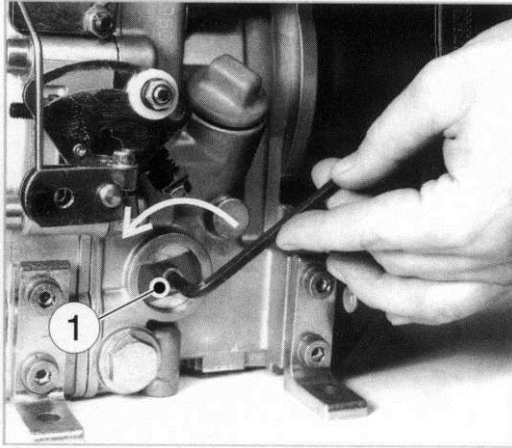

Loosen the screw « 1 » with approx. 5 rotations.

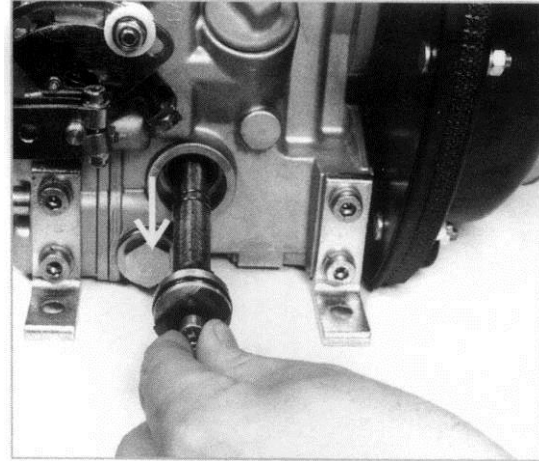

Remove the oil filter from housing.



Use an air line to blow out oil filter dirt from the inside outwards.

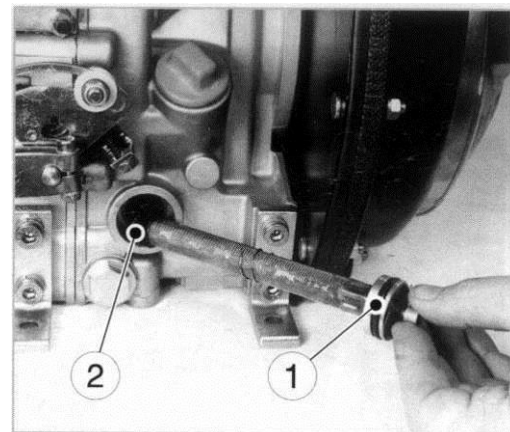

Check the joint washer « 1 » whether it is damaged. Replace it if necessary. Check the joint washer « 2 » whether it is damaged and correctly fitted. Replace the oil filter if necessary.

Lubricate joint washer before fitting.

Put in the oil filter and press until the limit stop.

Check whether tension springs sit close to oil filter with both ends "1" before tightening.

Check the oil level and restore to max. level if required.

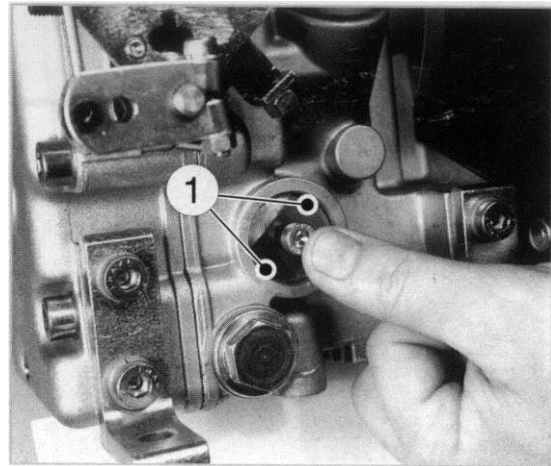

Checking the water trap

The intervals at which you check the water trap depend entirely on the amount of water in the fuel and the care taken when refuelling. However, you should check it at least once a week.

- Loosen the hexagonal screw "1" with approx. 3-4 rotations.
- Trap the drops which emerge in a transparent vessel. Since water has a greater specific gravity than diesel fuel, the water emerges before the diesel fuel. The two substances separate at a clearly visible line.
- As soon as diesel only emerges, retighten screw "1".

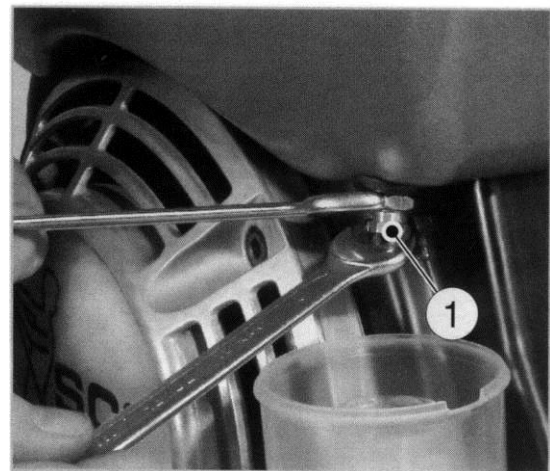

Cleaning the air cooling zone

Before cleaning, the engine must be stopped and allowed to cool down. If severely contaminated, clean the cooling fans on the cylinder and cylinder head, and also the fan blades in the flywheel. If necessary, contact your local HATZ service station.

Cleaning of the exhaust mesh inlet

Exhaust system components will naturally be hot and must not be touched while the engine is running or until it has cooled down after being stopped.

- Unscrew the hexagonal nut and remove the exhaust mesh insert.
- Remove any deposits in the mesh insert by means of a wire brush.
- Check the exhaust mesh insert for cracks or damage and, if necessary, replace with a new one.

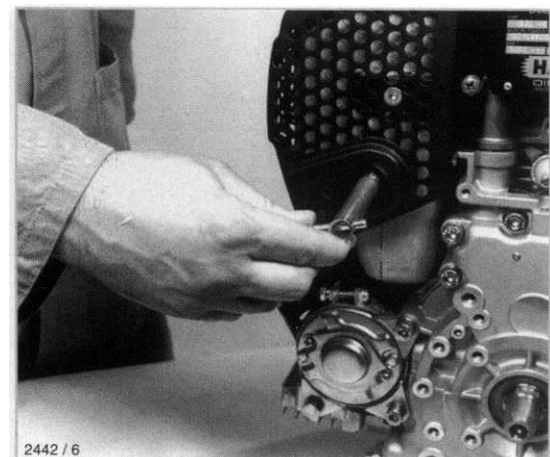

2442 / 6

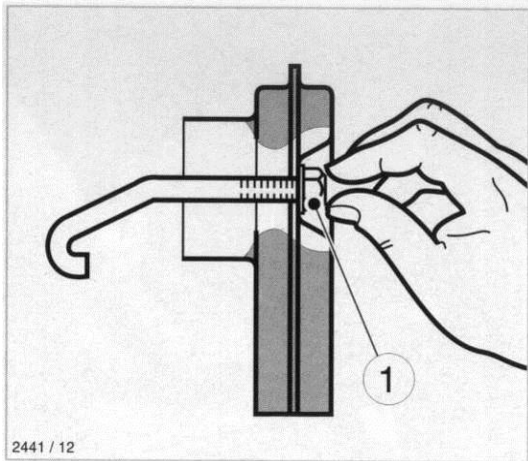

Screw on the hexagonal nut « 1 » by approx. 1 turn.

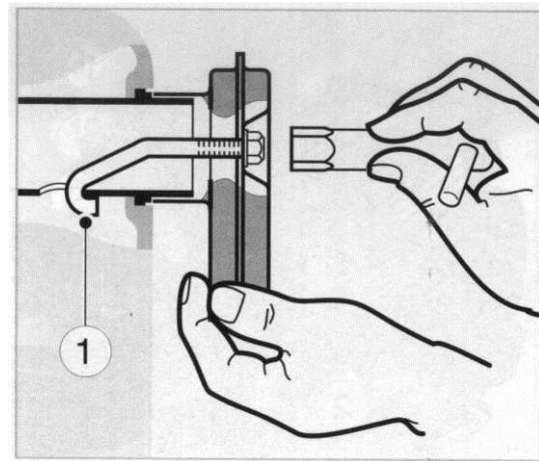

Insert exhaust screen with hoop « 1 » into hole, then pull outwards again so that the hoop is retained.

Tighten the hexagonal nut fully.

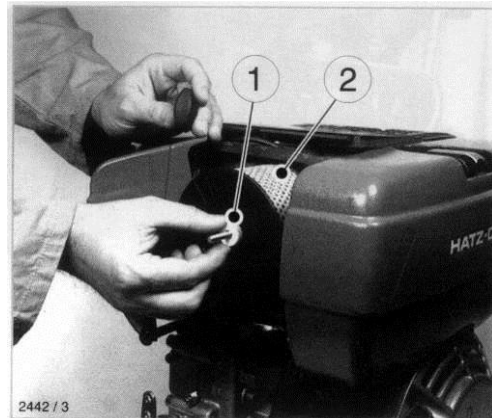
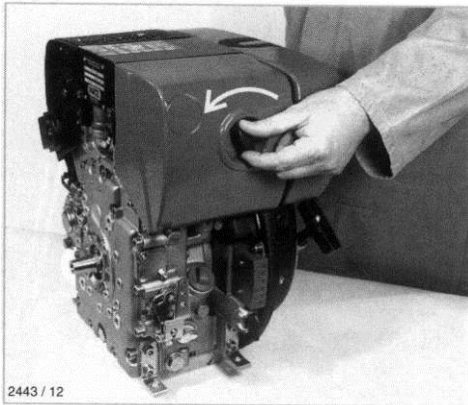

Air cleaner maintenance

- Remove the air cleaner cover.
- Unscrew and remove knurled nut "1" and take off air cleaner element "2".
- Clean the filter compartment and the cover. Dirt and other foreign bodies must not be allowed to enter the engine's air inlet points.
- Use compressed air to blow through the filter cartridge from the inside outwards until no further dirt emerges. The air pressure must not exceed 5 bar.
- Check the filter cartridge's gasket surface « 1 » for damage.
- Check the filter cartridge for cracks or any other type of damage to the paper filter by holding it inclined towards the light or by shining a light source through it.
- The slightest damage to the paper filter rules out it being used any longer.
- By wet or oily contamination, change the cartridge.
- Re-assemble the filter cartridge in the reverse order of work.

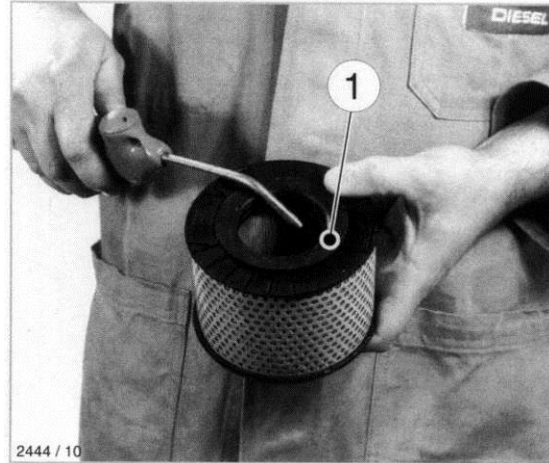
**Checking of the valve clearance and of the fuel filter**

Contact a HATZ-Service station to perform this maintenance.

7 Breakdowns: causes and cures

7.1 Breakdown-finding procedures

Should any breakdown occur during the use of the machine, turn it off. Let only qualified staff make any intervention other than the ones described in the previous section.

7.2 Trouble-shooting guide

Trouble	Possible source	Resolution
Engine lacks power	Tank run dry	Add fuel
	Air filter clogged	Clean or replace air filter
	Speed control lever does not remain in the selected position	Prevent speed control from moving
	Stronger fault	Contact nearest engine maintenance centre
Engine stops by itself during regular operation	Tank run dry	Add fuel
	Air filter restricted	Clean or replace air filter
	No oil pressure	Check the oil level
	Stronger fault	Contact nearest engine maintenance centre

7.3 Customer service

When ordering spare parts, please mention:

- The serial number (7 digits).
- The code of the part or the position from the exploded view or spare parts list.
- The exact denomination.
- The number of parts required.
- The delivery address.
- Please indicate clearly the means of transportation required such as "express" or "by air". Without specific instructions, we will forward the parts through the means which seem appropriate to us and but which is not always the quickest way.

Clear instructions will avoid problems and faulty deliveries.

If not sure, please send us the defective part.

In the case of a warranty claim, the part must always be returned for evaluation.

Spare parts for the engine can be ordered with the manufacturer of the engine or with their dealer, which is often quicker and cheaper.

This machine has been manufactured by Saint-Gobain Abrasives S.A.

190, Bd J.F.Kennedy

L- 4930 BASCHARAGE

Grand-Duché de Luxembourg.

Tel. : 00352- 50 401-1

Fax : 00352- 50 16 33

<http://www.construction.norton.eu>

e-mail: sales.nlx@saint-gobain.com

Guarantee can be claimed and technical support obtained from your local distributor where machines, spare parts and consumables can be ordered as well:

SAINT-GOBAIN ABRASIVES NV/SA
INDUSTRIELAAN 129
1070 ANDERLECHT /BRUSSEL
BELGIUM
TEL: +32 (0)2 267 21 00
FAX: +32 (0)2 267 84 24

SAINT-GOBAIN ABRASIVES, S.R.O.
POČERNICKÁ 272/96, MALEŠICE
108 00 PRAHA 10
CZECH REPUBLIC
TEL: +420 255 719 326
FAX: +420 255 719 321

SAINT-GOBAIN ABRASIVES A/S
ROBERT JACOBSENS VEJ 62A
2300 KØBENHAVN S
DENMARK
TEL: +45 4675 5244

PO BOX 643706
FORTUNE TOWER OFFICE 2106
JLT BLOCK C
(NEXT TO METRO STATION)
JUMEIRA LAKE TOWER, DUBAI
UNITED ARAB EMIRATES
TEL: +971 4 431 5154
FAX: +971 4 431 5434

SAINT-GOBAIN ABRASIFS
RUE DE L'AMBASSADEUR - B.P.8
78 702 CONFLANS CEDEX
FRANCE
TEL: +33 (0)1 34 90 40 00
FAX: +33 (0)1 39 19 89 56

SAINT-GOBAIN ABRASIVES GMBH
BIRKENSTRASSE 45-49
D-50389 WESSELING
GERMANY
TEL: +49 (0) 2236 703-1
+49 (0) 2236 8996-0
+49 (0) 2236 8911-0
FAX: +49 (0) 2236 703-367
+49 (0) 2236 8996-10
+49 (0) 2236 8911-30

FÜR DEN FACHHANDEL
ÖSTERREICH
TEL: +43 (00) 662 430 076

SAINT-GOBAIN ABRASIVES KFT.
1225 BUDAPEST
BÁNYALÉG U. 60/B.
HUNGARY
TEL: +36 1 371 22 50
FAX: +36 1 371 22 55

SAINT-GOBAIN ABRASIVI S.P.A
VIA PER CESANO BOSCONI 4
I-20094 CORSICO MILANO
ITALY
TEL: +39 02 44 851
FAX: +39 02 44 78 266

SAINT-GOBAIN ABRASIVES S.A.
190 RUE J.F. KENNEDY
L-4930 BASCHARAGE
GRAND DUCHE DE LUXEMBOURG
TEL: +352 50 401 1
FAX: +352 50 16 33
NO. VERT (FRANCE) 0800 906 903

SAINT-GOBAIN ABRASIFS, S.A.
2 ALLÉE DES FIGUIERS
AIN SEBAË - CASABLANCA
MOROCCO
TEL: +212 5 22 66 57 31
FAX: +212 5 22 35 09 65

SAINT-GOBAIN ABRASIVES BV
GROENLOSEWEG 28
7151 HW EIBERGEN
P.O. BOX 10
7150 AA EIBERGEN
THE NETHERLANDS
TEL: +31 545 466466
FAX: +31 545 474605

SAINT-GOBAIN ABRASIVES AS
POSTBOKS 11, ALNABRU,
0614 OSLO
BROBEKKVEIEN 84,
0582 OSLO
NORWAY
TEL: +47 63 87 06 00
FAX: +47 63 87 06 01

SAINT-GOBAIN HPM POLSKA SP. Z O.O.
UL. NORTON 1
62-600 KOŁO
POLAND
TEL: +48 63 26 17 100
FAX: +48 63 27 20 401

SAINT-GOBAIN ABRASIVOS, L. DA
ZONA INDUSTRIAL DA MAIA
I-SECTOR VIII, NO. 122
APARTADO 6050
4476 - 908 MAIA
PORTUGAL
TEL: +351 229 437 940
FAX: +351 229 437 949

SAINT-GOBAIN GLASS
BUSINESS UNIT ABRASIVI
PUNCT DE LUCRU: LOC.VETIS, JUD.
SATU MARE 447355
STR. CAREIULUI 11
PARC INDUSTRIAL RENOVATIO
ROMANIA
TEL: 0040-261-839.709
FAX: 0040-261-839.710

SG HPM RUS
58, F. ENGELS STR.
STROENIE 2
105082 MOSCOW
RUSSIA
TEL: +74 955 408 355
FAX: +74 959 373 224

SAINT-GOBAIN
ABRASIVES (PTY) LTD
2 MONTEER ROAD
ISANDO 1600
P.O. BOX 67
SOUTH AFRICA
TEL: +27 11 961 2000
FAX: +27 11 961 2184/5

SAINT-GOBAIN ABRASIVOS, S.A.
CTRA. DE GUIPÚZCOA, KM. 7,5
E-31195 BERRIOPLANO (NAVARRA)
SPAIN
TEL: +34 948 306 000
FAX: +34 948 306 042

SAINT-GOBAIN ABRASIVES AB
BOX 495
SE-191 24 SOLLENTUNA
SWEDEN
TEL: +46 8 580 881 00
FAX: +46 8 580 881 01

SAINT-GOBAIN INOVATIF
MALZEMELER VE AŞINDIRICI
SAN. TIC. A.Ş.
GOLD PLAZA, ALTAY ÇEŞME
MAHALLESİ, ÖZ SOKAK, NO:19/16
34843 MALTEPE-ISTANBUL,
TURKEY
TEL: 0090-216-217 12 50
FAX: 0090-216-442 40 74

SAINT-GOBAIN ABRASIVES LTD.
DOXEY RD
STAFFORD
ST16 1EA
UNITED KINGDOM
TEL: +44 1785 222 000
FAX: +44 1785 213 487

www.construction.norton.eu

Saint-Gobain Abrasives

190, Bd. J. F. Kennedy
L-4930 BASCHARAGE
LUXEMBOURG

Tel: ++352 50401-1

Fax: ++352 501633

e-mail: sales.nlx@saint-gobain.com